



KUSEL CLASSIC FLOOR SINK 6" SCH 10 OUTLET AND OPEN GRATE

	Depth {D}	Length {L}					
		12	18	24	30	36	
Width {W}	12	6	FS4-061-121206-O	FS4-061-121806-O	FS4-061-122406-O	FS4-061-123006-O	FS4-061-123606-O
		10	FS4-061-121210-O	FS4-061-121810-O	FS4-061-122410-O	FS4-061-123010-O	FS4-061-123610-O
	18	6	NA	FS4-061-181806-O	FS4-061-182406-O	FS4-061-183006-O	FS4-061-183606-O
		12	NA	FS4-061-181812-O	FS4-061-182412-O	FS4-061-183012-O	FS4-061-183612-O
		16	NA	FS4-061-181816-O	FS4-061-182416-O	FS4-061-183016-O	FS4-061-183616-O
	24	6	NA	NA	FS4-061-242406-O	FS4-061-243006-O	FS4-061-243606-O
12		NA	NA	FS4-061-242412-O	FS4-061-243012-O	FS4-061-243612-O	
22		NA	NA	FS4-061-242422-O	FS4-061-243022-O	FS4-061-243622-O	

Classic Floor Sink Body

Width: "W" (Grate Opening)
 Length: "L" (Grate Opening)
 Depth: "D"
 Outlet: 6" Sch 10
 Setting Tabs: 4 Tabs (2 per side)
 Finish: Standard Industrial
 Material: 14 GA T304 Stainless Steel

Open Grating:

10 GA Bearing Bars on 1-1/2" centers
 8 GA Side Banding Bars
 Continuous Weld

Basket: (Optional)

Perforated Body Basket
 1/8" holes
 2-1/2" deep

Outlet Strainer: (Optional)

Perforated Outlet Strainer - 1/8" holes

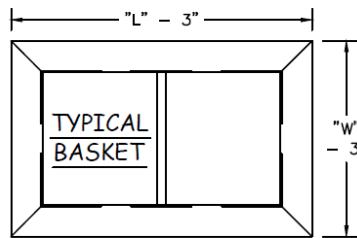
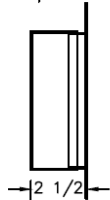
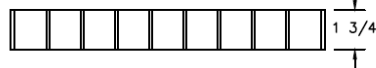
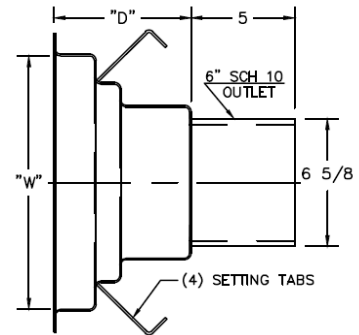
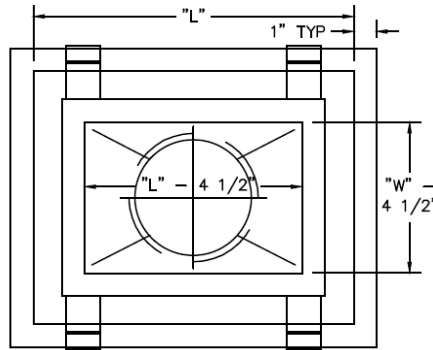
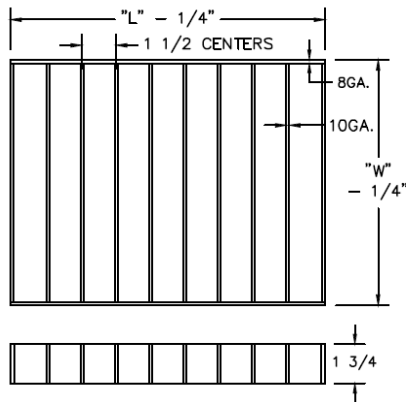

6" OUTLET STRAINER

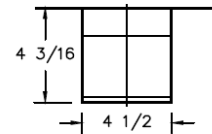

Sink

Basket / Strainer Options
(add to end of Part Number)

___ **Basket** -**B**

___ **Strainer** -**S**

___ **Basket & Strainer** -**Y**

Basket / Outlet Strainer for 6" Sch 10 Outlet (if ordered separately)							
		Length {L}					
		12	18	24	30	36	
Width {W}	12	Basket	12-14-276	12-14-277	12-14-278	12-14-279	12-14-280
		Strainer	12-14-309	12-14-309	12-14-309	12-14-309	12-14-309
	18	Basket	NA	12-14-281	12-14-282	12-14-283	12-14-284
		Strainer	NA	12-09-3799	12-09-3799	12-09-3799	12-09-3799
	24	Basket	NA	NA	12-14-285	12-14-286	12-14-287
		Strainer	NA	NA	12-09-3799	12-09-3799	12-09-3799

When submitting this request please include the following information in your email:

Your Name	Contact Info	Project Name	Location	Any special request
-----------	--------------	--------------	----------	---------------------